

480. DIMENSIONADO

APELLIDOS: _____

NOMBRE: _____

(firma)

1

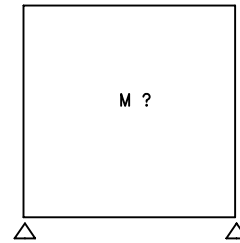
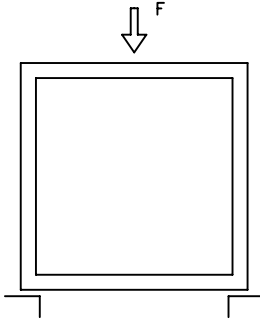

2

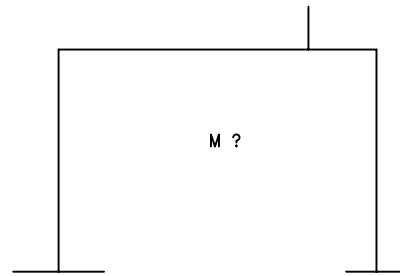
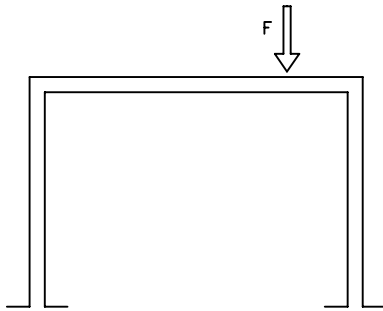

3

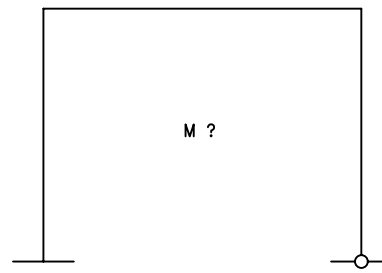
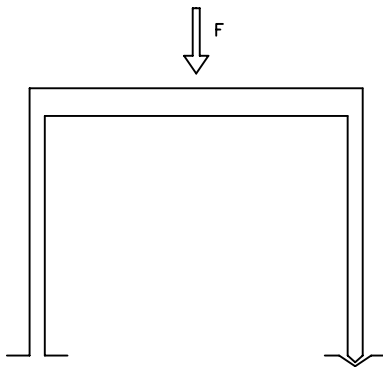

4

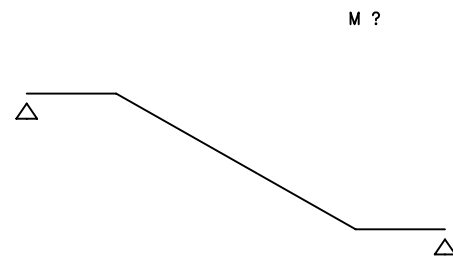
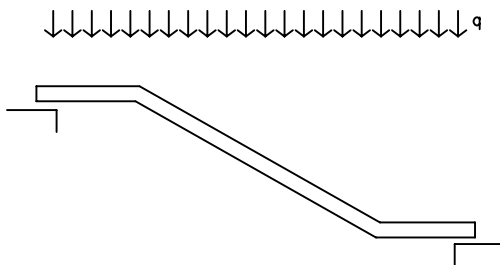

5

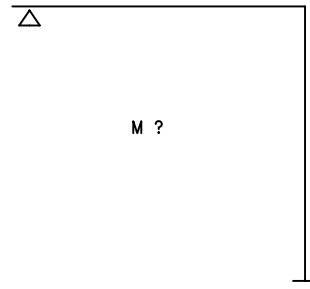
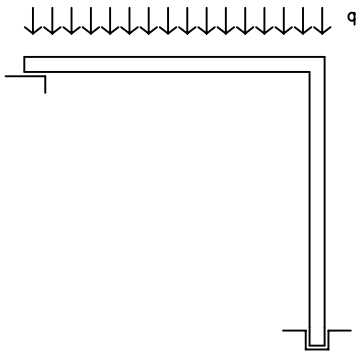

6

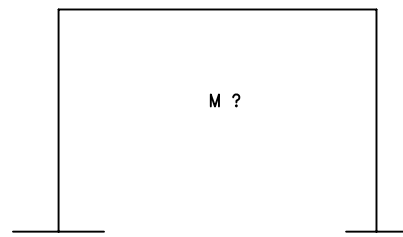
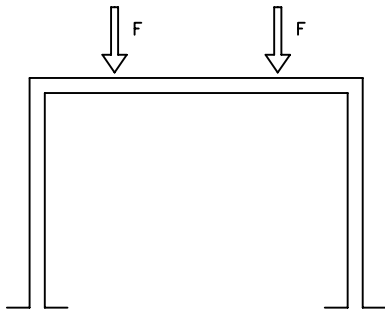

7

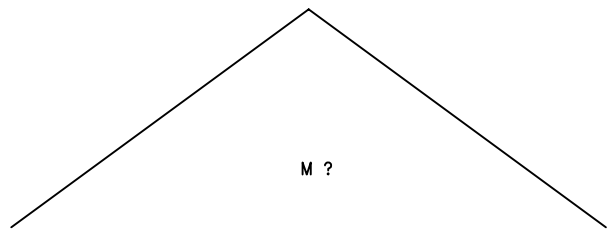
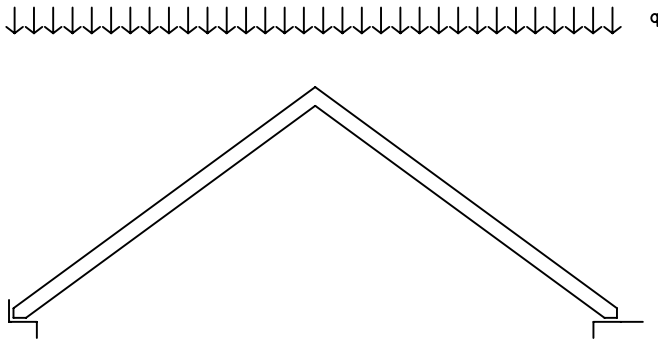

8

